

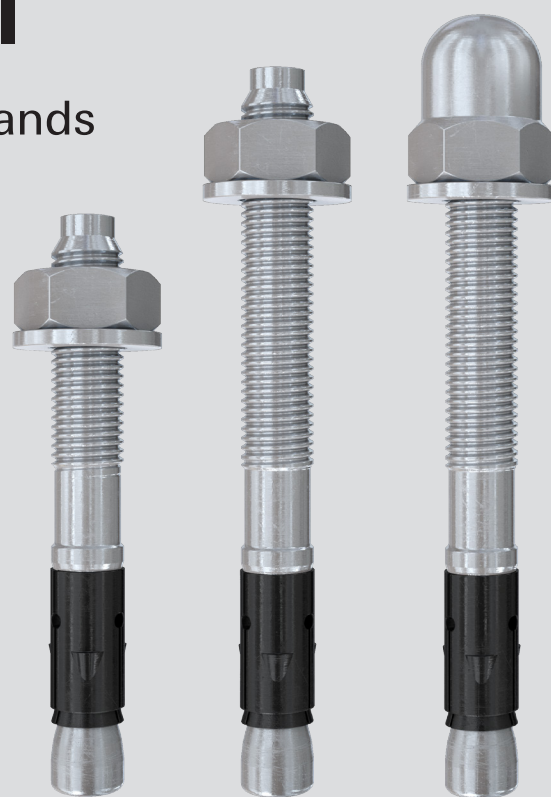

# fischer

## Bolt anchor FAZ II

The power anchor for highest demands



[www.rjfacades.com](http://www.rjfacades.com)  
Tel: +44 (0) 1483 898125

# Bolt anchor FAZ II

## For highest demands

## Powerful and flexible

The distinctive edge holds the expansion clip in position even with reinforcement hits, thus ensuring **safe installation**.

With a choice of pre-assembled **normal washer** or **large washer GS** and with washer HBS in compliance with wood construction standard DIN 1052 (not pre-assembled).

The protruding hammer-in pin **protects the thread** from damage during setting.

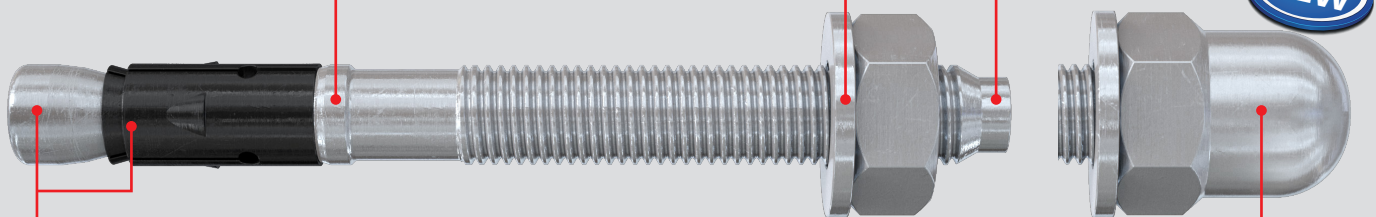

The interaction of cone and expansion clip significantly increases load-bearing capacity and makes **minimum edge distance and axial spacing possible**.

The eight new sizes of the special cap nut version (M10 and M12) can be used for the **application on sophisticated design**. They are also implemented in the ETA assessment.



## Variable embedment depths

Enables most accurate adaption on the loads (M 8 - M 16).

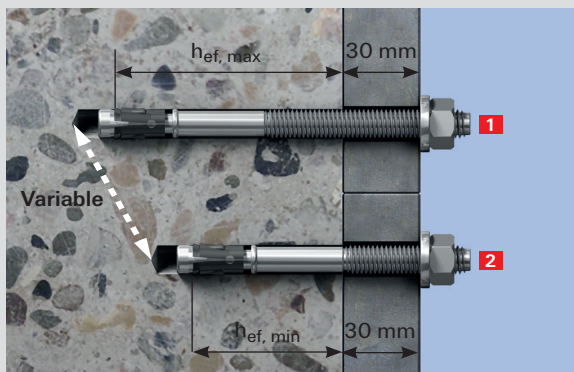

**1 Maximum load with maximum embedment depth FAZ II 10 A4**  
60 mm embedment depth = maximum permissible tension load of **6.2 kN** and shear load of **15.1 kN**.

Permissible loads may be calculated for embedment depth between 40 mm and 60 mm.

**2 Fast installation thanks to minimum embedment depth FAZ II 10 A4**  
40mm embedment depth = permissible tension load of **4.3 kN** and shear load of **11.3 kN**.

## Powerful and flexible

- The FAZ II is suitable for pre-positioned and push-through installation and is also ideal for stand-off installation.
- Experts report for use in concrete C12/15 and C80/95.
- The assessment document covers the use of hollow drills and diamond drills.



### Your advantages at a glance

- With the new ETA assessment for Option 1 the tension loads are increased up to 10% and the shear loads up to 17%. So fewer and smaller anchors are required.
- The minimum embedment depth (see example) makes considerably shorter drill hole depths possible, thus provides a noticeably faster installation and less rebar hits.
- The new cup nut, not only gives the option for a better and refined optical design but also, ensures an accident free installation.
- FAZ II 6: First bolt anchor with drill-hole diameter 6 mm and ETA Option 1 worldwide, for safe and approved anchorage.

### Approvals

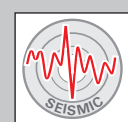
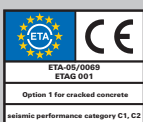

[www.rjfacades.com](http://www.rjfacades.com)  
Tel: +44 (0) 1483 898125

# Bolt anchor FAZ II K

## For highest demands

## Short and practical

The 12 sizes of FAZ II K in zinc-plated or stainless steel versions can **be used up to a fixture thickness of 20 mm.**

The shorter bolt with minimum embedment depth is the **economic choice** for numerous applications such as the fixing of cable trays and substructures for façades.

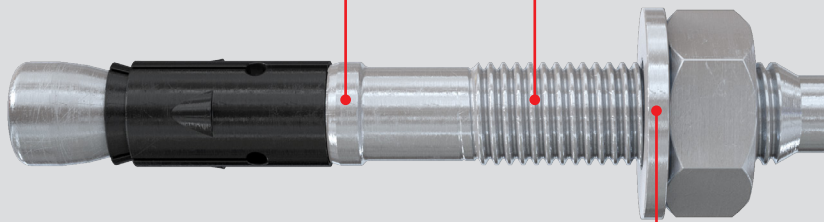

With a choice of **normal washer or large washer GS.**

### Short and practical

- The FAZ II K is suitable for pre-positioned and push-through installation.
- The small drill hole depth of the K-version speeds up installation even further and reduces the number of reinforcement hits.

### Your advantages at a glance

- The properties of the FAZ II K considerably minimise the drilling effort and the hammer blows required to drive in the bolt anchor, saving energy and installation time.
- The tried-and-trusted expansion clip ensures a high load-bearing capacity even with minimum embedment depth. This guarantees an unbeatable price-performance ratio.

### Approvals



### Recommendation

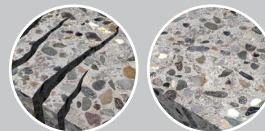

- Suitable for the following building materials:
  - Cracked concrete
  - Uncracked concrete

### Drill-hole preparation

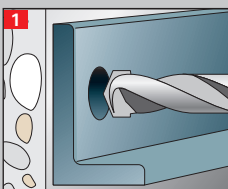

1 Create drill hole

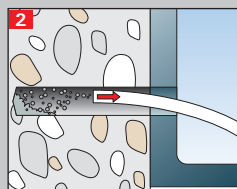

2 Clean drill hole

### Push through installation with hexagon nut

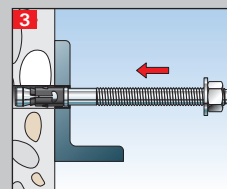

3 Drive in anchor

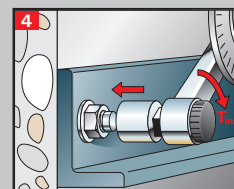

4 Apply installation torque

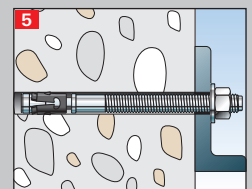

5 Finished!

### Push trough installation of the cup nut version with setting gauge

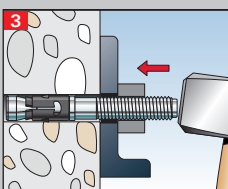

3 Set the fastener

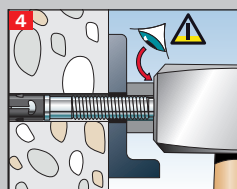

4 Check offset

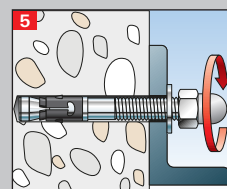

5 Turn on cup nut

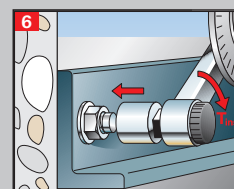

6 Apply installation torque

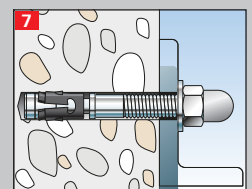

7 Finished!





# Applications

## Typical anchorage solutions for different building segments

### Metal construction

#### Railings



e. g. FAZ II 10/10 HA4

- With maximum embedment depth for maximum loads and minimum edge distance and axial spacing in cracked concrete
- For applications with sophisticated design, visually appealing



e. g. FAZ II 10/10 KA4

- With minimum embedment depth for use in thin concrete members from 80 mm thickness

### Façade construction

#### Façade substructure



e. g. FAZ II 12/10 GS A4

- With maximum embedment depth for heavy-duty façade substructures
- In stainless steel
- Version FAZ II GS for the even better alignment of brackets with long holes

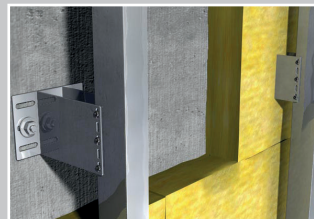

e. g. FAZ II 10/10 KA4

- With minimum embedment depth for minimum loads or shallow component thicknesses
- 27% less drilling effort compared with the maximum version and significantly fewer reinforcement hits

### Timber construction

#### Railings

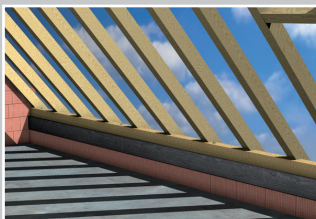

e. g. FAZ II 12/100 HBS

- With maximum embedment depth, ideal for anchoring sleepers/beams
- Also ideal for extreme usable lengths
- With extra-large washer version HBS in accordance with wood construction standard DIN 1052

#### Tension anchor



e. g. FAZ II 10/10 K GS

- With minimum embedment depth but without load reduction
- 27% less drilling effort (in comparison to maximum version)

### Sanitary / Heating / Electric

#### Pipe routes



e. g. FAZ II 6/10

- Suitable for fixing of pipe hangers, metal profiles or mounting rails
- Approved for single point anchorings

#### Cable trays



e. g. FAZ II 10/10 K

- With minimum embedment depth but without load reduction
- 27% less drilling effort towards the maximum version and far fewer reinforcement hits

# Applications

## Design examples

### Processing of thin or slim components, balcony railings under thin concrete plate

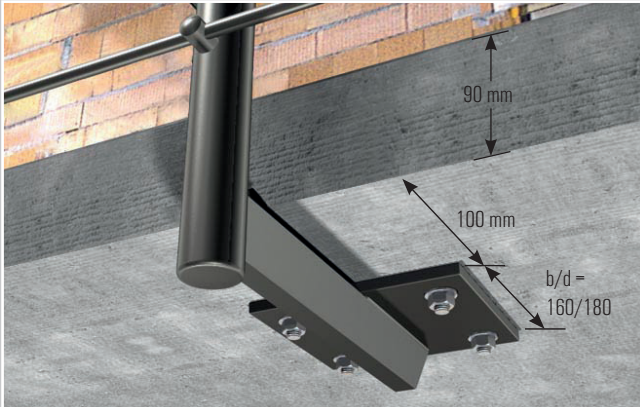

#### Basic conditions

- Fixing to the underside of the balcony
- Rail load 0.5 kN/m
- Length of balcony 2500 mm
- Rail height 1000 mm

### Installation of cable trays with suspended supports

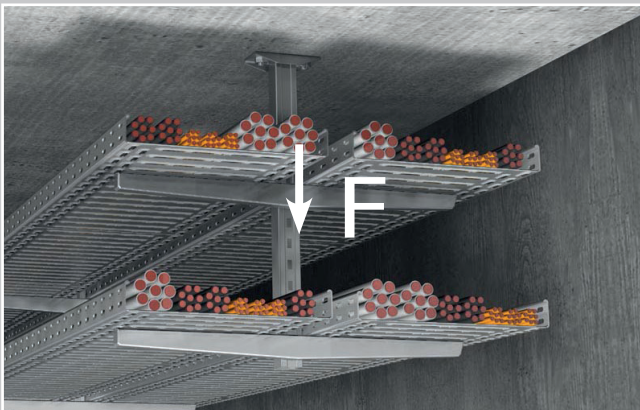

#### Basic conditions

- Cable trays
- 2 anchors per anchor plate
- Distance between anchors 140 mm
- Distance between the suspended supports 2500 mm
- Anchor plate 100 x 200 mm
- Thickness of concrete ceiling 200 mm

#### fischer

FAZ II 10/10 K

**8.6 kN** per anchor plate  
with **40 mm** embedment depth  
and **55 mm** drill hole depth

#### Competitor

Competitive product M 10/10

**8.6 kN** per anchor plate  
with **60 mm** embedment depth  
and **75 mm** drill hole depth

#### Advantages of the short version of the fischer bolt anchor FAZ II 10/10 K

- 27% less drilling effort
- Fewer reinforcement hits
- Significantly faster installation



# Range

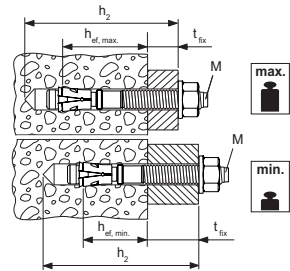

Bolt anchor FAZ II (maximum version)

Item	Art.-No.			Approval			Drill diameter $d_0$ [mm]	Min. drill hole depth for push-through installation $h_2$ [mm]	Anchor length $l$ [mm]	Maximum embedment depth with respective usable length		Minimum embedment depth with respective usable length		Thread $\varnothing \times$ length [mm]	Sales unit [pcs]
	Steel, zinc-plated gvz	stainless steel A4	highly corrosi- onresistant steel C	ETA	ICC	Seismic C1/C2 <sup>1)</sup>				$h_{ef, max.}$ [mm]	$t_{fix}$ [mm]	$h_{ef, min.}$ [mm]	$t_{fix}$ [mm]		
FAZ II 6/10	542621	542623	—	■	—	—	6	60	65	40	10	—	—	M 6 x 25	50
FAZ II 6/20	542622	542624	—	■	—	—	6	70	75	40	20	—	—	M 6 x 35	50
FAZ II 8/10	94871	501396	—	■	▲	C1	8	65	75	45	10	35 <sup>2)</sup>	20	M 8 x 38	50
FAZ II 8/10	—	—	501428	■	▲	C1	8	65	75	45	10	35 <sup>2)</sup>	20	M 8 x 38	10
FAZ II 8/30	94877	501399	—	■	▲	C1	8	85	95	45	30	35 <sup>2)</sup>	40	M 8 x 58	50
FAZ II 8/30	—	—	501429	■	▲	C1	8	85	95	45	30	35 <sup>2)</sup>	40	M 8 x 58	10
FAZ II 8/50	94878	501401	—	■	▲	C1	8	105	115	45	50	35 <sup>2)</sup>	60	M 8 x 78	50
FAZ II 8/100	94879	—	—	■	▲	C1	8	155	165	45	100	35 <sup>2)</sup>	110	M 8 x 128	25
FAZ II 8/160	503251	—	—	■	▲	C1	8	215	225	45	160	35 <sup>2)</sup>	170	M 8 x 100	20
FAZ II 10/10	94981	501403	—	■	▲	C1/C2	10	85	95	60	10	40	30	M 10 x 53	50
FAZ II 10/10	—	—	501430	■	▲	C1	10	85	95	60	10	40	30	M 10 x 53	10
FAZ II 10/20	94982	—	—	■	▲	C1/C2	10	95	105	60	20	40	40	M 10 x 63	25
FAZ II 10/20	—	501406	—	■	▲	C1/C2	10	95	105	60	20	40	40	M 10 x 63	50
FAZ II 10/30	94983	—	—	■	▲	C1/C2	10	105	115	60	30	40	50	M 10 x 73	25
FAZ II 10/30	—	501407	—	■	▲	C1/C2	10	105	115	60	30	40	50	M 10 x 73	50
FAZ II 10/30	—	—	503185	■	▲	C1	10	105	115	60	30	40	50	M 10 x 73	10
FAZ II 10/50	94984	501409	—	■	▲	C1/C2	10	125	135	60	50	40	70	M 10 x 93	20
FAZ II 10/70	—	501410	—	■	▲	C1/C2	10	145	155	60	70	40	90	M 10 x 113	20
FAZ II 10/80	94985	—	—	■	▲	C1/C2	10	155	165	60	80	40	100	M 10 x 123	20
FAZ II 10/100	94986	501411	—	■	▲	C1/C2	10	175	185	60	100	40	120	M 10 x 143	20
FAZ II 10/160	503252	501412	—	■	▲	—	10	235	245	60	160	40	180	M 10 x 193	20
FAZ II 12/10	95419	501413	—	■	▲	C1/C2	12	100	110	70	10	50	30	M 12 x 61	20
FAZ II 12/10	—	—	503186	■	▲	C1	12	100	110	70	10	50	30	M 12 x 61	10
FAZ II 12/20	95420	501415	—	■	▲	C1/C2	12	110	120	70	20	50	40	M 12 x 71	20
FAZ II 12/30	95421	501416	—	■	▲	C1/C2	12	120	130	70	30	50	50	M 12 x 81	20
FAZ II 12/30	—	—	501431	■	▲	C1	12	120	130	70	30	50	50	M 12 x 81	10
FAZ II 12/50	95446	501419	—	■	▲	C1/C2	12	140	150	70	50	50	70	M 12 x 101	20
FAZ II 12/60	—	501420	—	■	▲	C1/C2	12	150	160	70	60	50	80	M 12 x 111	20
FAZ II 12/80	95454	—	—	■	▲	C1/C2	12	170	180	70	80	50	100	M 12 x 131	20
FAZ II 12/100	95470	501421	—	■	▲	C1/C2	12	190	200	70	100	50	120	M 12 x 151	20
FAZ II 12/160	503253	—	—	■	▲	—	12	250	260	70	160	50	180	M 12 x 186	10

1) Only with maximum embedment depth

2) With minimum embedment depth only for statically indeterminate systems

# Range

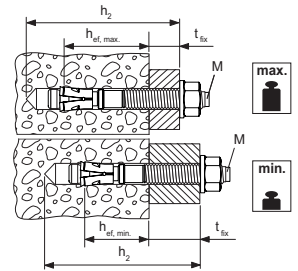
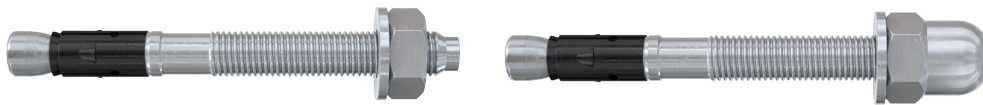

Bolt anchor FAZ II (maximum version) / bolt anchor FAZ II H (cap nut version)

Item	Art.-No.			Approval			Drill diameter $d_0$ [mm]	Min. drill hole depth for push-through installation $h_2$ [mm]	Anchor length $l$ [mm]	Maximum embedment depth with respective usable length		Minimum embedment depth with respective usable length		Thread $\phi \times$ length [mm]	Sales unit [pcs]
	Steel, zinc-plated gvz	stainless steel A4	highly corrosion-resistant steel C	ETA	ICC	Seismic C1/C2 <sup>1)</sup>				$h_{ef, max.}$ [mm]	$t_{fix}$ [mm]	$h_{ef, min.}$ [mm]	$t_{fix}$ [mm]		
	FAZ II 12/160	—	503180	—	■	▲	—	12	250	260	70	160	50	180	M 12 x 186
FAZ II 12/200	95605	—	—	■	▲	—	12	290	300	70	200	50	220	M 12 x 186	10
FAZ II 16/5	522124	—	—	■	▲	C1/C2	16	115	128	85	5	65	25	M 16 x 64	10
FAZ II 16/5	—	522125	—	■	▲	C1/C2	16	115	128	85	5	65	25	M 16 x 64	20
FAZ II 16/25	—	501423	—	■	▲	C1/C2	16	135	148	85	25	65	45	M 16 x 84	10
FAZ II 16/25	95836	—	501432	■	▲	C1	16	135	148	85	25	65	45	M 16 x 84	10
FAZ II 16/50	95864	—	503187	■	▲	C1	16	160	173	85	50	65	70	M 16 x 109	10
FAZ II 16/50	—	501424	—	■	▲	C1/C2	16	160	173	85	50	65	70	M 16 x 109	20
FAZ II 16/60	—	532570	—	■	▲	C1/C2	16	170	183	85	60	65	80	M 16 x 119	20
FAZ II 16/100	95865	501425	—	■	▲	C1/C2	16	210	223	85	100	65	120	M 16 x 159	10
FAZ II 16/160	503254	—	—	■	▲	C1/C2	16	270	283	85	160	65	180	M 16 x 189	10
FAZ II 16/200	95967	—	—	■	▲	—	16	310	323	85	200	65	220	M 16 x 189	10
FAZ II 16/250	95968	—	—	■	▲	—	16	360	373	85	250	65	270	M 16 x 100	10
FAZ II 16/300	96188	—	—	■	▲	—	16	410	423	85	300	65	320	M 16 x 100	10
FAZ II 20/30	46632	—	—	■	▲	C1/C2	20	155	172	100	30	—	—	M 20 x 54	5
FAZ II 20/30	—	501426	—	■	▲	C1/C2	20	155	172	100	30	—	—	M 20 x 54	4
FAZ II 20/60	46633	—	—	■	▲	C1/C2	20	185	202	100	60	—	—	M 20 x 84	5
FAZ II 20/60	—	503183	—	■	▲	C1/C2	20	185	202	100	60	—	—	M 20 x 84	4
FAZ II 20/160	503255	—	—	■	▲	C1/C2	20	285	302	100	160	—	—	M 20 x 100	5
FAZ II 24/30	46635	—	—	■	▲	C1	24	185	205	125	30	—	—	M 24 x 58	5
FAZ II 24/30	—	501427	—	■	▲	C1	24	185	205	125	30	—	—	M 24 x 58	4
FAZ II 24/60	46636	—	—	■	▲	C1	24	215	235	125	60	—	—	M 24 x 88	5
FAZ II 24/60	—	503184	—	■	▲	C1/C2	24	215	235	125	60	—	—	M 24 x 88	4
FAZ II 10/10 H <sup>2)</sup>	543392	543396	—	■	—	C1/C2	10	87	95	60	10	40	30	M 10 x 53	20
FAZ II 10/20 H <sup>2)</sup>	543393	543397	—	■	—	C1/C2	10	97	105	60	20	40	40	M 10 x 63	20
FAZ II 12/10 H <sup>2)</sup>	543394	543398	—	■	—	C1/C2	12	98.5	109	70	10	50	30	M 12 x 61	20
FAZ II 12/20 H <sup>2)</sup>	543395	543399	—	■	—	C1/C2	12	108.5	119	70	20	50	40	M 12 x 71	20

1) Only with maximum embedment depth

2) Available from spring 2018

# Range

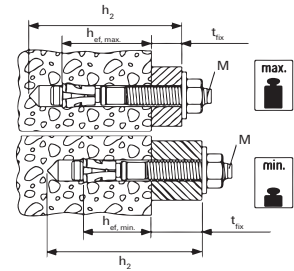
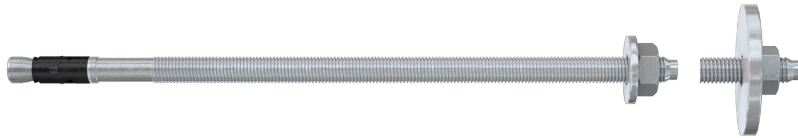

Bolt anchor FAZ II GS (with large washer) / FAZ II HBS (washer compliant to timber construction standard DIN 1052)

Item	Art.-No.		Approval	Drill diameter	Min. drill hole depth for push-through installation	Anchor length	Maximum embedment depth with respective usable length		Minimum embedment depth with respective usable length		Thread	Washer (outer diameter x thickness)	Sales unit	
	Steel, zinc-plated	stainless steel					$h_{ef, max.}$	$t_{fix}$	$h_{ef, min.}$	$t_{fix}$				$\varnothing \times$ length
	gvz	A4	ETA	$d_0$	$h_2$	$l$	[mm]	[mm]	[mm]	[mm]	[mm]	[mm]	[pcs]	
FAZ II 8/10 GS	94872	501398	■	C1	8	65	75	45	10	35 <sup>2)</sup>	20	M 8 x 38	22 x 2.5	50
FAZ II 8/30 GS	96189	501400	■	C1	8	85	95	45	30	35 <sup>2)</sup>	40	M 8 x 58	22 x 2.5	50
FAZ II 10/10 GS	96291	501405	■	C1/C2	10	85	95	60	10	40	30	M 10 x 53	25 x 3	50
FAZ II 10/30 GS	96297	—	■	C1/C2	10	105	115	60	30	40	50	M 10 x 73	25 x 3	25
FAZ II 10/30 GS	—	501408	■	C1/C2	10	105	115	60	30	40	50	M 10 x 73	25 x 3	50
FAZ II 12/10 GS	96303	501414	■	C1/C2	12	100	110	70	10	50	30	M 12 x 61	30 x 3	20
FAZ II 12/20 GS	502530	—	■	C1/C2	12	110	120	70	20	50	40	M 12 x 71	30 x 3	20
FAZ II 12/30 GS	96340	501418	■	C1/C2	12	120	130	70	30	50	50	M 12 x 81	30 x 3	20
FAZ II 12/50 GS	502531	—	■	C1/C2	12	140	150	70	50	50	70	M 12 x 101	30 x 3	20
FAZ II 12/80 GS	538430	—	■	C1/C2	12	170	180	70	80	50	100	M 12 x 131	44 x 4	20
FAZ II 12/100 GS	502532	—	■	C1/C2	12	190	200	70	100	50	120	M 12 x 151	30 x 3	20
FAZ II 12/100 GS	538702	—	■	C1/C2	12	190	200	70	100	50	120	M 12 x 151	44 x 4	20
FAZ II 12/120 GS	96367	—	■	C1/C2	12	210	220	70	120	50	140	M 12 x 171	30 x 3	20
FAZ II 12/120 GS	538703	—	■	C1/C2	12	210	220	70	120	50	140	M 12 x 171	44 x 4	20
FAZ II 12/140 GS	538433	—	■	C1/C2	12	230	240	70	140	50	160	M 12 x 186	44 x 4	20
FAZ II 12/160 GS	538431	—	■	C1/C2	12	250	260	70	160	50	180	M 12 x 186	44 x 4	20
FAZ II 12/160 GS	—	503181	■	—	12	250	260	70	160	50	180	M 12 x 186	44 x 4	20
FAZ II 12/180 GS	538434	—	■	C1/C2	12	270	280	70	180	50	200	M 12 x 186	44 x 4	20
FAZ II 12/200 GS	538432	—	■	C1/C2	12	290	300	70	200	50	220	M 12 x 186	44 x 4	20
FAZ II 16/160 GS	503261	—	■	C1/C2	16	270	283	85	160	65	180	M 16 x 189	56 x 5	10
FAZ II 16/160 GS	—	503182	■	C1/C2	16	270	283	85	160	65	180	M 16 x 100	56 x 5	4
FAZ II 16/200 GS	96370	—	■	—	16	310	323	85	200	65	220	M 16 x 189	56 x 5	10
FAZ II 12/100 HBS	522951	—	■	C1/C2	12	190	205	70	100	50	120	M 12 x 151	58 x 6	20
FAZ II 12/120 HBS	522952	—	■	C1/C2	12	210	225	70	120	50	140	M 12 x 171	58 x 6	20
FAZ II 16/160 HBS	522953	—	■	C1/C2	16	270	278	85	160	65	180	M 16 x 189	68 x 6	10
FAZ II 16/200 HBS	522954	—	■	—	16	310	328	85	200	65	220	M 16 x 189	68 x 6	10

1) Only with maximum embedment depth

2) With minimum embedment depth only for statically indeterminate systems



# Range

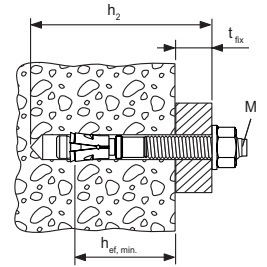
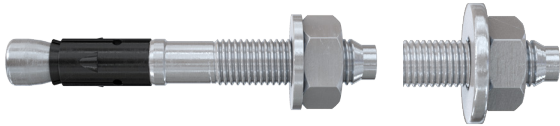

Bolt anchor FAZ II K / FAZ II K GS (short version)

Item	Art.-No.		Approval		Nominal drill diameter $d_0$ [mm]	Min. drill hole depth for push-through installation $h_2$ [mm]	Anchor length $l$ [mm]	Minimum embedment depth with respective usable length		Thread dia. x length [mm]	Washer (outer diameter x thickness) [mm]	Sales unit [pcs]
	Steel, zinc-plated gvz	stainless steel A4	ETA	Seismic C1/C2				$h_{ef, min.}$ [mm]	$t_{fix}$ [mm]			
FAZ II 8/5 K	538989	538990	■	—	8	45	60	35 <sup>1)</sup>	5	M 8 x 23	16 x 1.6	50
FAZ II 10/10 K	522108	522116	■	C1/C2	10	65	75	40	10	M 10 x 33	20 x 2.0	50
FAZ II 10/20 K	522110	—	■	C1/C2	10	75	85	40	20	M 10 x 43	20 x 2.0	25
FAZ II 10/20 K	—	522117	■	C1/C2	10	75	85	40	20	M 10 x 43	20 x 2.0	50
FAZ II 12/10 K	522118	522122	■	C1/C2	12	80	90	50	10	M 12 x 41	24 x 2.5	20
FAZ II 12/20 K	522119	522123	■	C1/C2	12	90	100	50	20	M 12 x 51	24 x 2.5	20
FAZ II 10/10 K GS	522115	—	■	C1/C2	10	65	75	40	10	M 10 x 33	25 x 3.0	50
FAZ II 12/10 K GS	522121	—	■	C1/C2	12	80	90	50	10	M 12 x 41	30 x 3.0	20

1) With minimum embedment depth only for statically indeterminate systems

# Loads

## Non-cracked concrete

Bolt anchor FAZ II, FAZ II K and FAZ II GS (HBS)

zinc plated steel / stainless steel / high corrosion resistant steel

Permissible loads of a single anchor in non-cracked normal concrete (concrete compression zone) of strength class C20/25 (~ B25) 1) 2) 3)										Minimum spacings while reducing the load		
Type	Material fixing element	Min. member thickness $h_{min}$ [mm]	Effective anchorage depth $h_{ef}$ 4) [mm]	Installation torque $T_{inst}$ [Nm]	Permissible tension load $N_{perm}$ 6) [kN]	Permissible shear load $V_{perm}$ 6) [kN]	Required edge distance (with one edge) for		Required spacing for Max. load $s_{cr}$ [mm]	Min. spacing $s_{min}$ 7) [mm]	Min. edge distance $c_{min}$ 7) [mm]	
							Max. tension load $c$ [mm]	Max. shear load $c$ [mm]				
FAZ II 6	gvz	80	40	8	3,6	3,4	45	55	120	35	45	
	A4				5,0	5,0	50	85				
	C											
FAZ II 8	gvz	80	35 5)	20	5,0	7,8	85	140	105	40	40	
		90	45		6,7		80	125				135
	A4	80	35 5)		5,0	9,6	85	175	105			
		90	45		6,7		80	160	135			
	C	80	35 5)		5,0		85	175	105			
		90	45		6,7		80	160	135			
FAZ II 10	gvz	90	40	45	6,1		12,2	80	205	120	40	45
		110	60		9,5			75	175			
	A4	90	40		6,1	15,1	80	260	120			
		110	60		9,5		75	220	180			
	C	90	40		6,1		80	260	120			
		110	60		9,5		75	220	180			
FAZ II 12	gvz	100	50	60	8,5		17,5	100	275	150	50	55
		120	70		10,5			80	240			
	A4	100	50		8,5	21,9	100	350	150			
		120	70		10,5		80	305	210			
	C	100	50		8,5		100	350	150			
		120	70		10,5		80	305	210			
FAZ II 16	gvz	140	65	110	12,6		31,4	130	410	195	65	65
			85		18,8			170	400			
	A4		65		12,6	39,9	130	535	195			
			85		18,8		170	520	255			
	C		65		12,6		130	535	195			
			85		18,8		170	520	255			
FAZ II 20	gvz	170	100	200	24,0		46,5	230	530	300	95	95
	A4						60,7		515			
	C											
FAZ II 24	gvz	210	125	270	33,6	62,9	265	630	375	100	135	
	A4					80,7		835				
	C											

For the design the complete assessment ETA-05/0069, issue date 03.07.2017 has to be considered. 8)

1) The partial safety factors for material resistance as regulated in the ETA as well as a partial safety factor for load actions of  $\gamma_L = 1.4$  are considered. As an single anchor counts e. g. an anchor with a spacing  $s \geq 3 \times h_{ef}$  and an edge distance  $c \geq 1.5 \times h_{ef}$ . Accurate data see ETA.

2) For higher concrete strength classes up to C50/60 higher permissible loads may be possible.

3) Drill method hammer drilling resp. hollow drilling. For further allowable drill methods see ETA.

4) Eff. anchorage depth: min. anchorage depth, max. anchorage depth

5) The anchorage depths smaller than 40 mm are only allowed for single anchors as part of a multiple fixing of non-structural systems.

6) For combinations of tensile loads, shear loads, bending moments as well as reduced edge distances or spacings (anchor groups) see ETA.

7) Minimum possible axial spacings resp. edge distance while reducing the permissible load.

8) The given loads refer to the European Technical Assessment ETA-05/0069, issue date 03.07.2017. Design of the loads according TR055/ETAG 001, Annex C, Method A (for static resp. quasi-static loads).



# Loads Cracked concrete

Bolt anchor FAZ II, FAZ II K and FAZ II GS (HBS)  
zinc plated steel / stainless steel / high corrosion resistant steel

Permissible loads of a single anchor in cracked normal concrete (concrete tension zone) of strength class C20/25 (~ B25) 1) 2) 3) 9)										Minimum spacings while reducing the load					
Type	Material fixing element	Min. member thickness $h_{min}$ [mm]	Effective anchorage depth $h_{ef}$ 4) [mm]	Installation torque $T_{inst}$ [Nm]	Permissible tension load $N_{perm}$ 6) [kN]	Permissible shear load $V_{perm}$ 6) [kN]	Required edge distance (with one edge) for		Required spacing for Max. load $s_{cr}$ [mm]	Min. spacing $s_{min}$ 7) [mm]	Min. edge distance $c_{min}$ 7) [mm]				
							Max. tension load $c$ [mm]	Max. shear load $c$ [mm]							
FAZ II 6	gvz	80	40	8	0,7	3,4	45	80	120	35	45				
	A4					5,0		125							
	C														
FAZ II 8	gvz	80	35 5)	20	2,6	7,8	40	200	105	35	40				
		90	45		3,8		45	185	135						
	A4	80	35 5)		2,6	8,9	40	235	105						
		90	45		3,8	9,6	45		135						
	C	80	35 5)		2,6	8,9	40		105						
		90	45		3,8	9,6	45		135						
	FAZ II 10	gvz	90		40	45	4,3	11,3	60			275	120	40	45
			110		60		6,2	12,2	65			255	180		
A4		90	40	4,3	11,3		60	275	120						
		110	60	6,2	15,1		65	325	180						
C		90	40	4,3	11,3		60	275	120						
		110	60	6,2	15,1		65	325	180						
FAZ II 12	gvz	100	50	60	6,1	17,5	75	400	150	50	55				
		120	70		9,5		100	350	210						
	A4	100	50		6,1	18,8	75	435	150						
		120	70		9,5	21,9	100	450	210						
	C	100	50		6,1	18,8	75	435	150						
		120	70		9,5	21,9	100	450	210						
FAZ II 16	gvz	140	65	110	9,0	28,7	100	545	195	65	65				
			85		13,4	31,4	130	585	255						
	A4		65		9,0	28,7	100	545	195						
			85		13,4	39,9	130	760	255						
	C		65		9,0	28,7	100	545	195						
			85		13,4	39,9	130	760	255						
FAZ II 20	gvz	170	100	200	17,1	44,6	150	745	300	95	85				
	A4														
	C														
FAZ II 24	gvz	210	125	270	24,0	57,5	170	840	375	100	100				
	A4														
	C														

For the design the complete assessment ETA-05/0069, issue date 03.07.2017 has to be considered. 8)

1) The partial safety factors for material resistance as regulated in the ETA as well as a partial safety factor for load actions of  $\gamma_L = 1.4$  are considered. As a single anchor counts e.g. an anchor with a spacing  $s \geq 3 \times h_{ef}$  and an edge distance  $c \geq 1.5 \times h_{ef}$ . Accurate data see ETA.

2) For higher concrete strength classes up to C50/60 higher permissible loads may be possible.

3) Drill method hammer drilling resp. hollow drilling. For further allowable drill methods see ETA.

4) Eff. anchorage depth: min. anchorage depth, standard anchorage depth, max. anchorage depth

5) The anchorage depths smaller than 40 mm are only allowed for single anchors as part of a multiple fixing of

non-structural systems.

6) For combinations of tensile loads, shear loads, bending moments as well as reduced edge distances or spacings (anchor groups) see ETA.

7) Minimum possible axial spacings resp. edge distance while reducing the permissible load.

8) The given loads refer to the European Technical Assessment ETA-05/0069, issue date 03.07.2017. Design of the loads according TR055/ETAG 001, Annex C, Method A (for static resp. quasi-static loads).

9) A reinforcement in the concrete to prevent splitting is required. The width of the cracks has to be limited under consideration of the splitting forces at  $w_k \sim 0.3\text{mm}$ .



# fischer FIXPERIENCE

## The design and information software suite



- The modular design program includes engineering software and application modules.
- The software is based on international design standards (ETAG 001 and EC2, such as EC1, EC3 and EC5), including the national application documents. All common force and measurement units are available.
- Incorrect input will be recognized and the software gives tips to get a correct result. This ensures a safe and reliable design every time.
- The graphical display can easily be rotated through 360°, panned, tilted or zoomed as required.
- The 3D display gives a detailed and realistic image.
- The “live update” feature helps to keep the program up to date ensuring you are always working with the latest version.
- Free download and updates at [www.fischer.de/fixperience-en](http://www.fischer.de/fixperience-en)

## Our service to you



We are available to you at any time as a reliable partner to offer technical support and advice:

- Our products range from chemical resin systems to steel anchors through to nylon anchors.
- Competence and innovation through own research, development and production.
- Global presence and active sales service in over 100 countries.
- Qualified technical consulting for economical and compliant fastening solutions. Also on-site at the construction site if requested.
- Training sessions, some with accreditation, at your premises or at the fischer ACADEMY.
- Design and construction software for demanding applications.

## This is what fischer stands for



FIXING SYSTEMS



AUTOMOTIVE SYSTEMS



FISCHERTECHNIK



CONSULTING

See the extensive main catalogue or visit our website at [www.fischer.de](http://www.fischer.de) for information about the complete fischer range